

## CUPS WITH SUPPORT



These traditional cup-shaped vacuum cups are suited for gripping and handling small objects with flat, slightly concave or convex surfaces.

This series of widely used cups have diameters ranging from 4 to 9 mm and are normally available in standard compounds: natural para rubber N, oil-resistant rubber A and silicon S. They can be cold-assembled with no adhesive onto a nickel-plated brass support.

The support has been specially shaped to perfectly fit with the cup and it is equipped with a male threaded pin to optimise the fastening to the machine.

These cups are extremely easy to replace; for the spare part, in fact, all you have to do is request the cup indicated in the table in the desired compound.

Cups in special compounds indicated at page 21 and supports in different materials can be provided upon request in minimum quantities to be defined in the order.

### CUPS

Art.	Force Kg	A ∅	B ∅	D ∅	E	F	H
01 04 10 *	0.03	3	1.5	4	6.0	7.0	7.5
01 05 10 *	0.05	3	1.5	5	6.0	7.0	8.0
01 06 10 *	0.07	3	1.5	6	6.0	7.0	8.0
01 07 07 *	0.10	5	2.0	7	6.0	6.0	7.0
01 08 10 *	0.12	5	2.5	8	6.0	7.0	8.0
01 09 07 *	0.15	5	2.0	9	5.5	6.0	7.0

\* Complete the code indicating the compound: A= oil-resistant rubber; N= natural para rubber; S= silicon

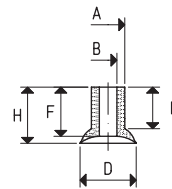

### SUPPORTS

Art.	A ∅	B ∅	D ∅	E	F	G	H	Support material	Cup art.	Weight g
00 08 01	M5	7	2.90	3	5	10	18	brass	01 04 10	4
									01 05 10	
									01 06 10	
00 08 02	M5	7	4.75	3	5	10	18	brass	01 07 07	4
									01 08 10	
									01 09 07	

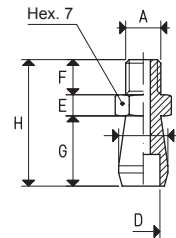

### CUPS WITH SUPPORT

Art.	Force Kg	A ∅	B ∅	D ∅	E	F	G	H	Cup Art.	Support Art.	Weight g
08 04 10 *	0.03	M5	7	4	3	5	13.0	21.0	01 04 10	00 08 01	4
08 05 10 *	0.05	M5	7	5	3	5	13.5	21.5	01 05 10	00 08 01	4
08 06 10 *	0.07	M5	7	6	3	5	13.5	21.5	01 06 10	00 08 01	4
08 07 07 *	0.10	M5	7	7	3	5	13.5	21.5	01 07 07	00 08 02	4
08 08 10 *	0.12	M5	7	8	3	5	13.5	21.5	01 08 10	00 08 02	4
08 09 07 *	0.15	M5	7	9	3	5	12.5	20.5	01 09 07	00 08 02	4

\* Complete the code indicating the compound: A= oil-resistant rubber; N= natural para rubber; S= silicon

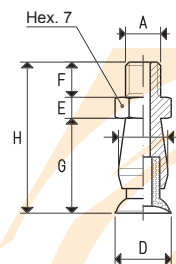

## CUPS WITH SUPPORT

These traditional cup-shaped vacuum cups are suited for gripping and handling small objects with flat, slightly concave or convex surfaces.

This series of widely used cups have diameters ranging from 10 to 45 mm and are normally available in standard compounds: natural para rubber N, oil-resistant rubber A and silicon S.

They can be cold-assembled with no adhesive onto a nickel-plated brass or anodised aluminium support. The support has been specially shaped to perfectly fit with the cup and it is equipped with a male threaded pin to optimise the fastening to the machine.

These cups are extremely easy to replace; for the spare part, in fact, all you have to do is request the cup indicated in the table in the desired compound.

Cups in special compounds indicated at page 21 and supports in different materials can be provided upon request in minimum quantities to be defined in the order.

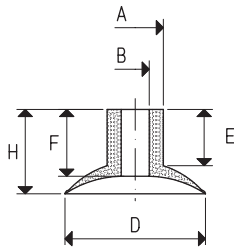

CUPS

Art.	Force Kg	A Ø	B Ø	D Ø	E	F	H
01 10 10 *	0.19	7	4.0	10	8.5	8.5	11.0
01 12 10 *	0.28	8	4.0	12	8.0	9.0	11.0
01 15 10 *	0.44	8	4.0	15	8.0	9.5	12.0
01 18 10 *	0.63	8	4.0	18	8.0	9.5	12.0
01 20 10 *	0.78	8	4.0	20	8.0	9.5	12.0
01 22 10 *	0.95	8	4.0	22	8.0	10.0	13.0
01 25 15 *	1.23	12	6.0	25	10.0	11.5	16.0
01 30 15 *	1.76	12	6.0	30	10.0	12.5	17.0
01 35 15 *	2.40	15	10.0	35	10.0	11.5	16.0
01 40 15 *	3.14	15	10.0	40	10.0	12.5	18.0
01 45 15 *	3.98	15	10.0	45	10.0	14.5	23.0

\* Complete the code indicating the compound: A= oil-resistant rubber; N= natural para rubber; S= silicon

SUPPORTS

Art.	A Ø	D Ø	E	F	G	H	T	Support material	Cup art.	Weight g
00 08 03	G1/8"	5.5	5	8	7.0	20.0	12	brass	01 10 10	9
									01 12 10	
									01 15 10	
									01 18 10	
									01 20 10	
									01 22 10	
00 08 05	G1/8"	7.5	5	8	9.5	22.5	12	brass	01 25 15	10
									01 30 15	
									01 35 15	
00 08 20	G1/4"	12.0	8	14	10.0	32.0	17	aluminium	01 40 15	11
									01 45 15	
									01 45 15	

CUPS WITH SUPPORT

Art.	Force Kg	A Ø	D Ø	E	F	G	H	T	Cup Art.	Support Art.	Weight g
08 10 10 *	0.19	G1/8"	10	5	8	11	24	12	01 10 10	00 08 03	9.0
08 12 10 *	0.28	G1/8"	12	5	8	11	24	12	01 12 10	00 08 03	9.6
08 15 10 *	0.44	G1/8"	15	5	8	12	25	12	01 15 10	00 08 03	9.7
08 18 10 *	0.63	G1/8"	18	5	8	12	25	12	01 18 10	00 08 03	9.7
08 20 10 *	0.78	G1/8"	20	5	8	12	25	12	01 20 10	00 08 03	9.8
08 22 10 *	0.95	G1/8"	22	5	8	13	26	12	01 22 10	00 08 03	10.2
08 25 15 *	1.23	G1/8"	25	5	8	16	29	12	01 25 15	00 08 05	12.0
08 30 15 *	1.76	G1/8"	30	5	8	17	30	12	01 30 15	00 08 05	12.7
08 35 15 *	2.40	G1/4"	35	8	14	16	38	17	01 35 15	00 08 20	13.6
08 40 15 *	3.14	G1/4"	40	8	14	18	40	17	01 40 15	00 08 20	14.1
08 45 15 *	3.98	G1/4"	45	8	14	23	45	17	01 45 15	00 08 20	17.6

\* Complete the code indicating the compound: A= oil-resistant rubber; N= natural para rubber; S= silicon

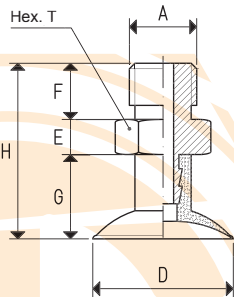
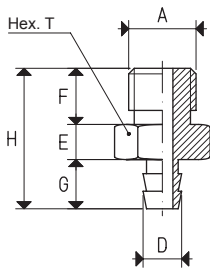

## CUPS WITH SUPPORT

1



These traditional cup-shaped vacuum cups are suited for gripping and handling small objects with flat, slightly concave or convex surfaces.

This series of widely used cups have diameters ranging from 10 to 45 mm and are normally available in standard compounds: natural para rubber N, oil-resistant rubber A and silicon S.

They can be cold-assembled with no adhesive onto a nickel-plated brass or anodised aluminium support. The support has been specially shaped to perfectly fit with the cup and it is equipped with a male threaded pin to optimise the fastening to the machine.

These cups are extremely easy to replace; for the spare part, in fact, all you have to do is request the cup indicated in the table in the desired compound.

Cups in special compounds indicated at page 21 and supports in different materials can be provided upon request in minimum quantities to be defined in the order.

### CUPS

Art.	Force Kg	A Ø	B Ø	D Ø	E	F	H
01 10 10 *	0.19	7	4.0	10	8.5	8.5	11.0
01 12 10 *	0.28	8	4.0	12	8.0	9.0	11.0
01 15 10 *	0.44	8	4.0	15	8.0	9.5	12.0
01 18 10 *	0.63	8	4.0	18	8.0	9.5	12.0
01 20 10 *	0.78	8	4.0	20	8.0	9.5	12.0
01 22 10 *	0.95	8	4.0	22	8.0	10.0	13.0
01 25 15 *	1.23	12	6.0	25	10.0	11.5	16.0
01 30 15 *	1.76	12	6.0	30	10.0	12.5	17.0
01 35 15 *	2.40	15	10.0	35	10.0	11.5	16.0
01 40 15 *	3.14	15	10.0	40	10.0	12.5	18.0
01 45 15 *	3.98	15	10.0	45	10.0	14.5	23.0

\* Complete the code indicating the compound: A= oil-resistant rubber; N= natural para rubber; S= silicon

### SUPPORTS

Art.	A Ø	D Ø	E	F	G	H	T	Support material	Cup art.	Weight g
00 08 04	G1/8"	5.5	13	10	7.0	20.0	12	brass	01 10 10	8.1
									01 12 10	
									01 15 10	
									01 18 10	
									01 20 10	
									01 22 10	
00 08 14	G1/8"	7.5	13	10	9.5	22.5	12	brass	01 25 15	9.8
									01 30 15	
									01 35 15	
00 08 21	G1/4"	12.0	17	13	10.0	27.0	17	aluminium	01 40 15	9.3
									01 45 15	

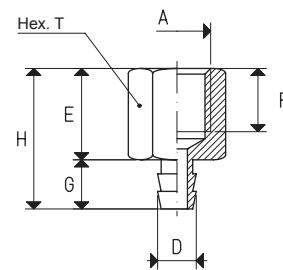
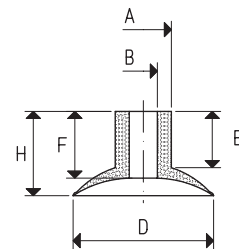

### CUPS WITH SUPPORT

Art.	Force Kg	A Ø	D Ø	E	F	G	H	T	Cup Art.	Support Art.	Weight g
08 10 25 *	0.19	G1/8"	10	13	10	11	24	12	01 10 10	00 08 04	8.1
08 12 25 *	0.28	G1/8"	12	13	10	11	24	12	01 12 10	00 08 04	8.7
08 15 25 *	0.44	G1/8"	15	13	10	12	25	12	01 15 10	00 08 04	8.8
08 18 25 *	0.63	G1/8"	18	13	10	12	25	12	01 18 10	00 08 04	8.8
08 20 25 *	0.78	G1/8"	20	13	10	12	25	12	01 20 10	00 08 04	9.3
08 22 25 *	0.95	G1/8"	22	13	10	13	26	12	01 22 10	00 08 04	9.3
08 25 25 *	1.23	G1/8"	25	13	10	16	29	12	01 25 15	00 08 14	11.8
08 30 25 *	1.76	G1/8"	30	13	10	17	30	12	01 30 15	00 08 14	12.5
08 35 25 *	2.40	G1/4"	35	17	13	16	33	17	01 35 15	00 08 21	11.9
08 40 25 *	3.14	G1/4"	40	17	13	18	35	17	01 40 15	00 08 21	12.4
08 45 25 *	3.98	G1/4"	45	17	13	23	40	17	01 45 15	00 08 21	15.9

\* Complete the code indicating the compound: A= oil-resistant rubber; N= natural para rubber; S= silicon

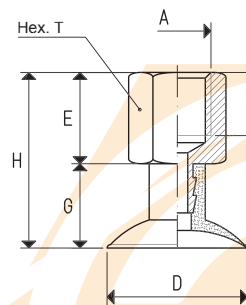

## CUPS WITH SUPPORT

These traditional cup-shaped vacuum cups are suited for gripping and handling small objects with flat, slightly concave or convex surfaces.

This series of widely used cups have diameters ranging from 25 to 35 mm and are normally available in standard compounds: natural para rubber N, oil-resistant rubber A and silicon S.

They can be cold-assembled with no adhesive onto a nickel-plated brass support.

The support has been specially shaped to perfectly fit with the cup and it is equipped with a male threaded pin to optimise the fastening to the machine.

These cups are extremely easy to replace; for the spare part, in fact, all you have to do is request the cup indicated in the table in the desired compound.

Cups in special compounds indicated at page 21 and supports in different materials can be provided upon request in minimum quantities to be defined in the order..

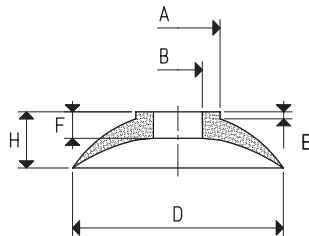

CUPS

Art.	Force Kg	A Ø	B Ø	D Ø	E	F	H
01 25 10 *	1.23	12	6	25	2	3.5	8
01 30 10 *	1.76	12	6	30	1	3.5	8
01 35 10 *	2.40	12	6	35	1	3.5	8

\* Complete the code indicating the compound: A= oil-resistant rubber; N= natural para rubber; S= silicon

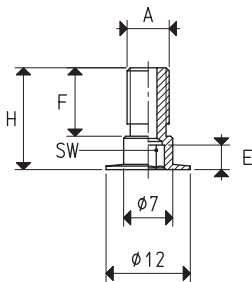

SUPPORTS

Art.	A Ø	E	F	H	SW	Support material	Cup art.	Weight g
00 08 08	M6	3.5	10	14.5	3	brass	01 25 10	2.7
							01 30 10	
							01 35 10	
00 08 60	G1/8"	4.0	10	14.5	4	brass	01 25 10	5.6
							01 30 10	
							01 35 10	

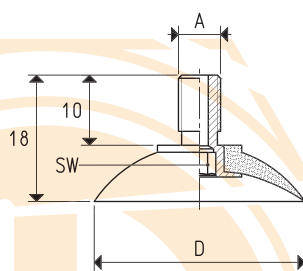

CUPS WITH SUPPORT

Art.	Force Kg	A Ø	SW	D Ø	Cup Art.	Support Art.	Weight g
08 25 10 *	1.23	M6	3	25	01 25 10	00 08 08	3.9
08 25 11 *	1.23	G1/8"	4	25	01 25 10	00 08 60	6.8
08 30 10 *	1.76	M6	3	30	01 30 10	00 08 08	4.6
08 30 11 *	1.76	G1/8"	4	30	01 30 10	00 08 60	7.5
08 35 10 *	2.40	M6	3	35	01 35 10	00 08 08	5.1
08 35 11 *	2.40	G1/8"	4	35	01 35 10	00 08 60	8.0

\* Complete the code indicating the compound: A= oil-resistant rubber; N= natural para rubber; S= silicon

## CUPS WITH SUPPORT

These traditional cup-shaped vacuum cups are suited for gripping and handling small objects with flat, slightly concave or convex surfaces.

This series of widely used cups have diameters ranging from 45 to 60 mm and are normally available in standard compounds: natural para rubber N, oil-resistant rubber A and silicon S.

They can be cold-assembled with no adhesive onto an anodised aluminium support.

The support has been specially shaped to perfectly fit with the cup and it is equipped with a male threaded pin to optimise the fastening to the machine. Moreover, those with 1/4" thread have an M8 threaded hole, to allow the possible insertion of a calibrated grub screw (see page 1.118) to reduce the amount of sucked air. These cups are extremely easy to replace; for the spare part, in fact, all you have to do is request the cup indicated in the table in the desired compound.

Cups in special compounds indicated at page 21 and supports in different materials can be provided upon request in minimum quantities to be defined in the order.



### CUPS

Art.	Force Kg	A Ø	B Ø	C Ø	D Ø	E	F	G	H	I
01 45 10 *	3.98	15	10	--	45	5	9.5	--	18	--
01 60 10 *	7.06	15	10	25	60	4	--	10	22	2.5

\* Complete the code indicating the compound: A= oil-resistant rubber; N= natural para rubber; S= silicon

### SUPPORTS

Art.	A Ø	E	C Ø	Support material	Cup art.	Weight g
00 08 22	G1/4"	10	M8	aluminium	01 45 10	5.9
					01 60 10	
00 08 44	G1/8"	--	--	aluminium	01 45 10	5.1
					01 60 10	
00 08 313	M6	--	--	brass	01 45 10	3.3
					01 60 10	
00 08 314	M8	--	--	brass	01 45 10	4.3
					01 60 10	
00 08 92	M10	--	--	brass	01 45 10	5.2
					01 60 10	

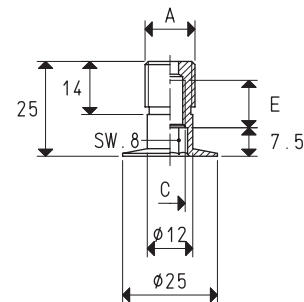
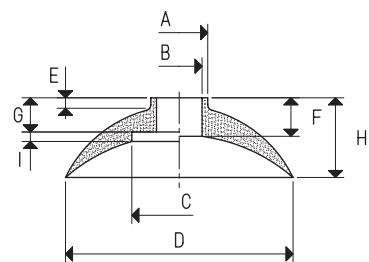

### CUPS WITH SUPPORT

Art.	Force Kg	A Ø	D Ø	M Ø	Cup Art.	Support Art.	Weight g
08 45 10 *	3.98	G1/4"	45	M8	01 45 10	00 08 22	12.6
08 45 11 *	3.98	G1/8"	45	--	01 45 10	00 08 44	11.8
08 45 12 *	3.98	M6	45	--	01 45 10	00 08 313	10.0
08 45 13 *	3.98	M8	45	--	01 45 10	00 08 314	11.0
08 45 14 *	3.98	M10	45	--	01 45 10	00 08 92	11.9

\* Complete the code indicating the compound: A= oil-resistant rubber; N= natural para rubber; S= silicon

### CUPS WITH SUPPORT

Art.	Force Kg	A Ø	D Ø	M Ø	Cup Art.	Support Art.	Weight g
08 60 10 *	7.06	G1/4"	60	M8	01 60 10	00 08 22	20.8
08 60 11 *	7.06	G1/8"	60	--	01 60 10	00 08 44	20.0
08 60 12 *	7.06	M6	60	--	01 60 10	00 08 313	18.2
08 60 13 *	7.06	M8	60	--	01 60 10	00 08 314	19.2
08 60 14 *	7.06	M10	60	--	01 60 10	00 08 92	20.1

\* Complete the code indicating the compound: A= oil-resistant rubber; N= natural para rubber; S= silicon

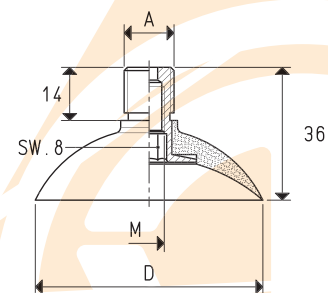
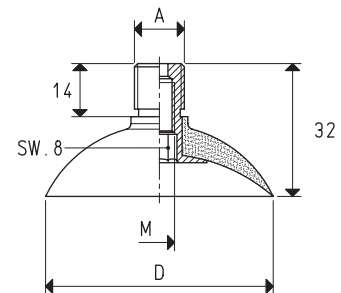

## CUPS WITH SUPPORT

These traditional cup-shaped vacuum cups are suited for gripping and handling small objects with flat, slightly concave or convex surfaces.

This series of widely used cups have diameters of 85 mm and are normally available in standard compounds: natural para rubber N, oil-resistant rubber A and silicon S.

They can be cold-assembled with no adhesive onto an anodised aluminium support.

The support has been specially shaped to perfectly fit with the cup and it is equipped with a male threaded pin to optimise the fastening to the machine. Moreover, those with 1/4" thread have an M8 threaded hole, to allow the possible insertion of a calibrated grub screw (see page 1.118) to reduce the amount of sucked air.

These cups are extremely easy to replace; for the spare part, in fact, all you have to do is request the cup indicated in the table in the desired compound.

Cups in special compounds indicated at page 21 and supports in different materials can be provided upon request in minimum quantities to be defined in the order.

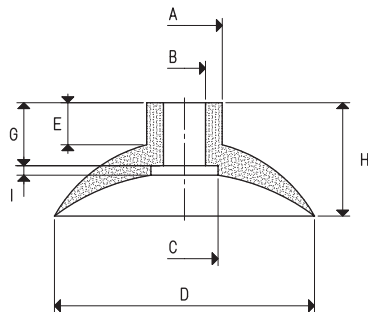

CUPS

Art.	Force Kg	A Ø	B Ø	C Ø	D Ø	E	G	H	I
01 85 10 *	14.18	25	15	25	85	16	23	41	4.0

\* Complete the code indicating the compound: A= oil-resistant rubber; N= natural para rubber; S= silicon

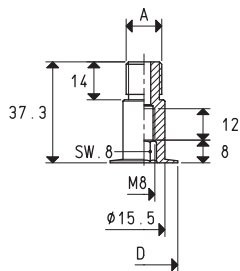

SUPPORTS

Art.	A Ø	D Ø	Support material	Cup art.	Weight g
00 08 28	G1/4"	25	aluminium	01 85 10	13.4
00 08 136	G1/8"	25	aluminium	01 85 10	9.2
00 08 91	M10x1,25	25	brass	01 85 10	

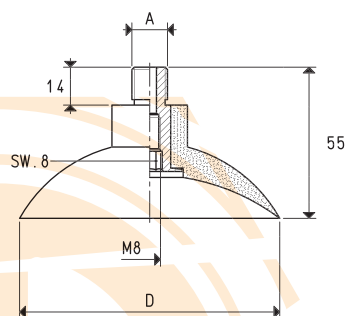

CUPS WITH SUPPORT

Art.	Force Kg	A Ø	D Ø	Cup Art.	Support Art.	Weight g
08 85 10 *	14.18	G1/4"	85	01 85 10	00 08 28	49.3
08 85 12 *	14.18	G1/8"	85	01 85 10	00 08 136	45.1

\* Complete the code indicating the compound: A= oil-resistant rubber; N= natural para rubber; S= silicon

## CUPS WITH SUPPORT

1

These traditional cup-shaped vacuum cups are suited for gripping and handling small objects with flat, slightly concave or convex surfaces.

This series of widely used cups have diameters of 85 mm and are normally available in standard compounds: natural para rubber N, oil-resistant rubber A and silicon S.

They can be cold-assembled with no adhesive onto an anodised aluminium support.

The support has been specially shaped to perfectly fit with the cup and it is equipped with a female threaded pin to optimise the fastening to the machine.

These cups are extremely easy to replace; for the spare part, in fact, all you have to do is request the cup indicated in the table in the desired compound.

Cups in special compounds indicated at page 21 and supports in different materials can be provided upon request in minimum quantities to be defined in the order.



### CUPS

Art.	Force Kg	A ∅	B ∅	C ∅	D ∅	E	G	H	I
01 85 10 *	14.18	25	15	25	85	16	23	41	4.0

\* Complete the code indicating the compound: A= oil-resistant rubber; N= natural para rubber; S= silicon

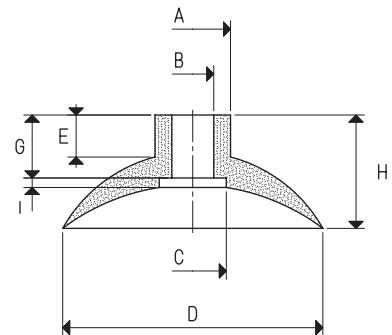

### SUPPORTS

Art.	A ∅	B ∅	Support material	Cup art.	Weight g
00 08 29	15.5	M12	aluminium	01 85 10	6.6
00 08 46	15.5	G1/4"	aluminium	01 85 10	6.5

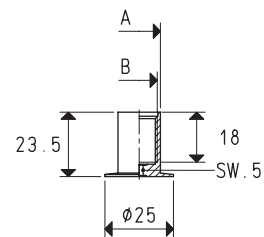

### CUPS WITH SUPPORT

Art.	Force Kg	A ∅	D ∅	H	Cup Art.	Support Art.	Weight g
08 85 25 *	14.18	G1/4"	85	41	01 85 10	00 08 46	42.4
08 85 26 *	14.18	M12	85	41	01 85 10	00 08 29	42.5

\* Complete the code indicating the compound: A= oil-resistant rubber; N= natural para rubber; S= silicon

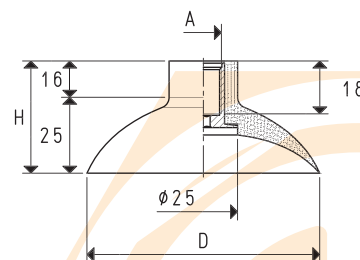

3D drawings available at [www.vuototecnica.net](http://www.vuototecnica.net)